

# User manual:



## Careful!

EACH USER OR PERSON WHO NEEDS TO STEP IN OR USE THIS KIT SHOULD READ CAREFULLY AND FULLY ALL THE INSTRUCTION PAGES CONTAINED IN THIS MANUAL.

PLEASE FOLLOW THEM SCRUPULOUSLY BEFORE USING THIS **LIFT-MTB** PRODUCT, OTHERWISE YOU WILL BE EXPOSED TO SERIOUS DAMAGE AND/OR RISK COMPROMISING YOUR LEGAL RIGHTS.

KEEP THIS MANUAL BECAUSE IT CONTAINS IMPORTANT INFORMATION ABOUT YOUR SECURITY.

DON'T TRY TO DO THE ASSEMBLY AND DEMOUNTING OPERATIONS OF THIS NEW **LIFT-MTB** PRODUCT ALONE IF YOU DON'T HAVE THE NECESSARY SKILLS!

*Always seek the help of a specialist mechanic. Follow the assembly and dismantling instructions carried out in this manual scrupulously and remember that you do so at your exclusive risk and peril.*

**NOTE:** Like every instruction manual, it is subject to change. To find out, contact your dealer periodically, or visit our website ([www.lift-mtb.com](http://www.lift-mtb.com)) to receive updates.

*This manual is a guide designed to help you get the kit right and safe on your bike. Tracking the various observations contained in this manual will guarantee you the best performance and reliability of your system, and thus avoid the most basic errors that are often caused by accidents during the assembly, use or handling of the **LIFT-MTB** engine kit.*

*The word **WARNING** informs you that failure to comply with the indications could cause damage to both the tooling and the user.*

## GENERAL SECURITY NOTES:

- *LIFT-MTB's powertraining devices have been designed exclusively for use on private land, for two-wheeled vehicles moved by human propulsion at the base. Any other application is a danger condition to which LIFT-MTB disclaims any responsibility.*
- *LIFT-MTB assist or motorizing devices are high-performance products that offer more power than conventional support and motorization and requires a degree of dexterity. Be very careful, as using too high a speed can cause a loss of control of the vehicle and possible injury to the user or any other person.*
- *The user has a responsibility to learn the correct techniques of use: consult the Bicycle Owner's Manual and a specialized bicycle dealer if in doubt.*
- *Try the assistance or motorization system on a flat, leveled and unobstructed surface before reaching rougher terrain*
- *Always control your speed, make sure you are able to stop, use the system only in an open place, when you are sure not to hit anything and at a reasonable speed. Inadequate installation and use of the LIFT-MTB system can result in loss of control or an accident, with unpredictable consequences and the possibility of serious injury.*
- *Do not insert hands into moving or able-to-move parts, use sturdy five-fingered gloves that do not reduce the sensitivity and ability of the socket.*
- *Do not change the system settings in order to obtain different services than those provided by the manufacturer (example: 36-volt battery)*
- *Before attacking any assembly operation, carefully examine the work area, trying to avoid possible hazardous conditions. Avoid working in obscure conditions, gather and use the right tools.*
- *Please concentrate properly and take all precautions before using components that can cause damage*
- *It is useful while using your bicycle to wear a helmet and drive with caution and responsibility.*
- *All extraordinary handling operations must be carried out only and exclusively by a qualified person authorized by LIFT-MTB.*
- *Make sure the system is off, battery disconnected before performing any intervention.*
- *A high load on the system (total weight greater than 100 kg and a slope greater than 15%) necessities the respective reduction of speed as well as regular breaks to avoid overheating of the system.*

## ENVIRONMENTAL NOTE

*In order to protect the environment, you must recycle your batteries through a specialized facility once it is out of use.*

**WARNING:** *The net brake, used in certain phases of assembly, is dangerous in case of contact with the eyes or with the skin.*



## PART 1: The installation:

We have done this manual in a very precise way so that it is as complete as possible, which can give at first glance an impression of complexity.

Rest assured, once assimilated, the steps are simple if you have any knowledge of bike mechanics.

Some steps are performed only once during the first assembly: this will be specified in subtitle. The text will then be in a grayed-out table, and in italics.

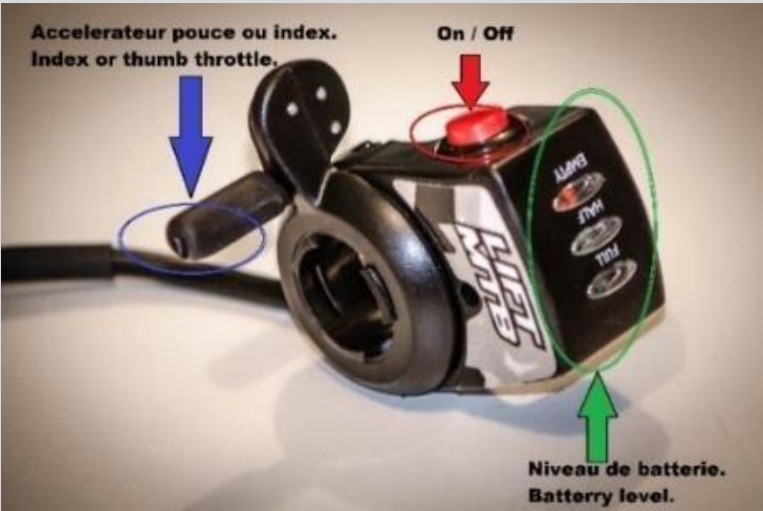
Once in focus, during subsequent fixtures and dismantlings, only the 2/8/8/9/10/11/12/13 steps are required.

Installing accelerator control	Photos
<p><b><i>(Step only required on first edit)</i></b></p> <p><i>-The accelerator can be mounted to the right or left indifferently depending on your preferences.</i></p> <p><i>But on the right, the rear speed switching controller can interfere with the operation of the accelerator.</i></p> <p><b><i>-We recommend a left mount</i></b>, you will then accelerate either:</p> <p><b><i>-1- With the phalanx of the index</i></b> finger (this position is generally the most neutral and the least tiring for long odds)</p> <p><b><i>-2- On the left thumb</i></b> (this position is more effective on technical parts ,but can be more tiring in the long run.. )</p> <p><i>Photos: mounting left side (index finger) and left thumb.</i></p> <p><i>-Take your handle apart, place the controller tighten it with the help of the small BTR screw</i></p> <p><i>Warning: Do not use a carbon handlebar with the accelerator, the sharp point screw too strong could damage the fiber Carbon with a significant risk of handlebar breakage.</i></p> <p><i>-Adjust the brake lever settings and other controls in relation to this new throttel to make you feel comfortable.</i></p> <p><i>-For your safety, be careful not to interfere with the operation of the brake with this new throttel. Be sure to test before use that everything works well.</i></p>	  

### **Accelerator control interface:**

In the parts pack you have a small interface piece, which improves the ergonomics of the throttle in the left index position. **This is for us the best solution regarding ergonomics for long mounts.**

However, it is not voluntarily installed to give you the freedom to use it or not.

To do the first tests and determine if this solution is the best for you, you can try taping the interface on the throttel.



If this suits you you can fix this in a sustainable way by drilling in defined places 3 holes of 2mm and positioning the specific screws, below the two ways to use the throttel, index finger and thumb:



## **2- Take off your crank**

To do this, use your crank and tooling specific to your crank model if necessary (specific tooling or crank extractor may be required).

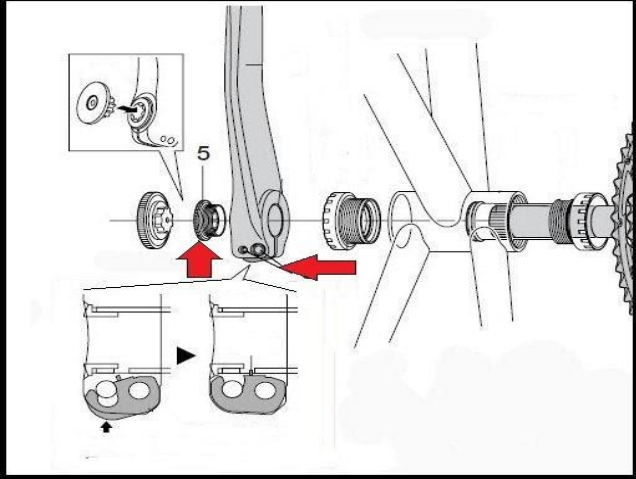
Since this can vary from mount to mount, keep track of the number and position of the rigging rings that are positioned for setting your crank and chaine guide (if you have one), you can use the memo at the end of the guide to record the information and facilitate reassembly later.

<b>Disassembly</b>	<b>Photos</b>
<p data-bbox="129 416 746 499"><b><u>Shimano Hollowtech crank disassembly procedure</u></b></p> <p data-bbox="70 539 804 701">Fully unscrew the 2 small BTR screws, unlock and remove the axle spindel screw (thanks to the shimano ref tool: TL-FC16), remove the left arm, remove the chain, then simply pull on the right crank or tap slightly to the mallet on the left side pedal axis to extract the arm (photo below left).</p> <p data-bbox="86 994 788 1077"><b><u>Disassembly for race models facing Race face CINCH, X TYPE and SRAM GXP and DUB</u></b></p> <p data-bbox="70 1160 804 1285">Remove the chain, fully currency the smallest OF the BTR screws inside the right crank, to extract the crank, simply pull on the left crank or tap slightly to the mallet on the right side axis to extract the ame (pictured below right).</p> <p data-bbox="70 1630 804 1749"><b><u>If you don't need addatator for ISCG tab's , you now have your bike without crank only with the bottom bracket</u></b> <b><u>(As in the photo attached.)</u></b></p>	 <p data-bbox="831 427 1469 904">A technical diagram showing the disassembly of a Shimano Hollowtech crank. It illustrates the crank arms, the axle, and the bottom bracket. Red arrows indicate the removal of the BTR screws and the extraction of the crank arms. A callout shows a close-up of a BTR screw being removed.</p>  <p data-bbox="836 949 1481 1429">A close-up photograph of the Shimano Hollowtech crank disassembly process. A red arrow points to the BTR screw being removed from the crank arm. A Shimano TL-FC16 tool is shown being used to remove the screw.</p>  <p data-bbox="839 1487 1493 1912">A photograph showing the bottom bracket after the crank has been removed. The bottom bracket is visible, and the ISCG tab is present.</p>

### **-3-Pre-assembly of the system for adjustment of alignments.**

**(Necessary step only on the first set-up)**

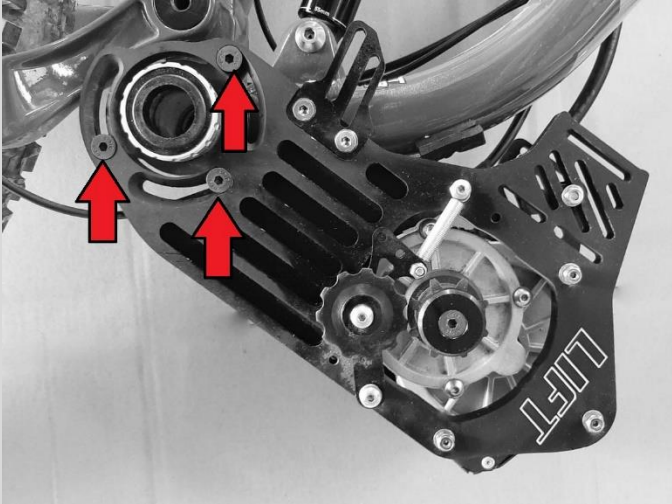
<b>LIFT-MTB system pre-assembly</b>	<b>Photos</b>
<p><i>-The LIFT-MTB system is screwed with 3 BTR screws on the ISCG tabs on your frame (plots provided at the base to receive an chain guide)</i></p> <p><i>If your frame doesn't have these tabs, you should use the ISCG adapter ring available in the "accessories" section of our website</i></p> <p><i>-You will initially temporarily screw the system with the 3 shortest BTR screws.</i></p> <p><i>-Place the system parallel to the ground, or at the bottom as in the photo attached.</i></p> <p><i>This temporary positioning will make the engine more accessible, allowing you to adjust the alignment more easily.</i></p>	



## **-4- Set the number of stalling washers needed on the pedal axis**

**(Necessary step in the first set-up:**

### **Set the number of stalling washers needed on the crank spindle axle.**

-Once the system is mounted, you need to set the number of stalling washers needed between the crank and the bottom bracket bearing.

-Assemble the right arm with the crank spindle axle, tighten the right arm, then add wedge washers to get a minimum of 4mm of wedges at first so that the free wheel of the arm does not rub on the bottom bracket bearing.

#### **WARNING:**

For the system to work well, you must have a number of calibration rings greater than or equal to 4mm thick between the arm and the bottom bracket (as pictured attached) otherwise the tray may rub against the engine support.

-Insert the right arm and axle spindle set into the bottom bracket, and make sure there are enough washers so that the crank does not touch any other parts when it is rotating.

-Adjust as best you can to ensure that the chain line is good and the axle is centered.

-Check that there is a minimum space of 4mm between the engine main plate, and the 38t sprocket (as in the photo attached), but also between all the other rotating parts or fixed parts including the 3 screws for plate fixation.

-If there is not enough space between the fixed and moving parts (or if the axis is too off-center), add the calibration washers needed to function properly (as pictured opposite).

-In order to save time on your future mounts, be sure to note in the memo at the end of the document the number of rings used.

**Note** For some frame with very small Q factor, it is possible to shift the attachment of the sprocket (as in the photo attached fig2) for have better center for the crank axle.

### **Photos**

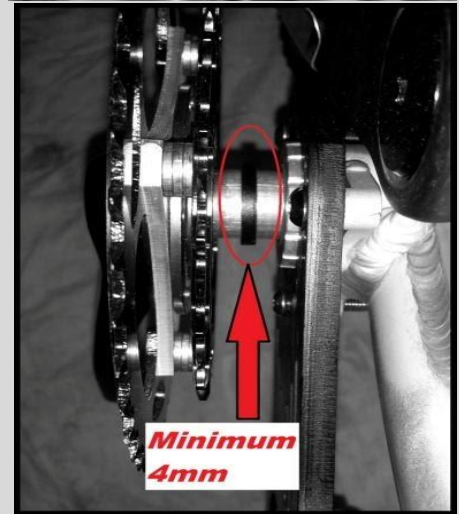
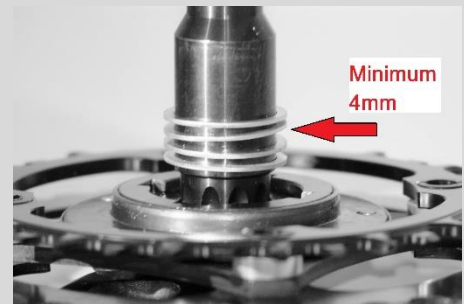

## **-5- Engine centering.**

***(Necessary step only on the first set-up)***

### **Engine centering**

**WARNING: This is the most important step in keeping your kit running smoothly!**

To avoid any derailment that could damage your kit, the engine 8t cogs must be in front of the tendon wheel and the primary transmission sprocket (the largest 38t sprocket) see photo attached.

-Place the right arm and axle set on your bottom bracket, place this set against the BB, then check the alignment of the set.

-The 8t cog has a normal functional play of a few millimeters in translation from right to left: put the cogs in the middle position (neither in a right stop nor in a left stop) for the initial setting.

-WARNING: The 38t sprocket is sometime not very straight from 3mm to 5mm, when you turn the cranks back...

**This is due to the adjustments of the free wheel, this is normal.**

-To get a good adjustment you will align the engine with the 8mm nuts at the 3 screws of the engine attachment, tightening and loosening the nuts on either side of the turntable in order to have a perfect alignment. (See photo attached).

You can also in some cases change the alignment with the spacer on the crank axle (see stage 4).

**Warning: Torque tightening these 8mm nuts is 3Nm maximum.**

-Check the perfect engine alignment with a set and the perfect alignment of the engine as in the photos attached.

**WARNING:** A good alignment of the 8T cog /plate and chain tendon is essential to the proper functioning of the kit. It is imperative that you check it regularly.

If the system is noisy at the chain check the alignment.

-For to save time on your future mounts, be sure to write down in the memo at the end of the document the number of spacer you use on crank axle.

You can (depending versions) add a 4th screw attachment to fix the engine (see photo opposite, screw No. 4 in red), this screw attachment as well as the counter nuts are provided in the parts kit, before placing. the screw, check that there is a minimum insertion in the threading of 8mm (maximum tightening torque 3Nm).

### **Photos**

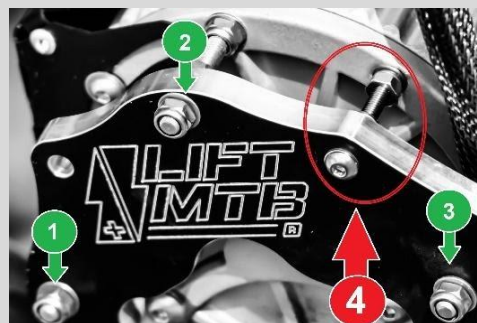
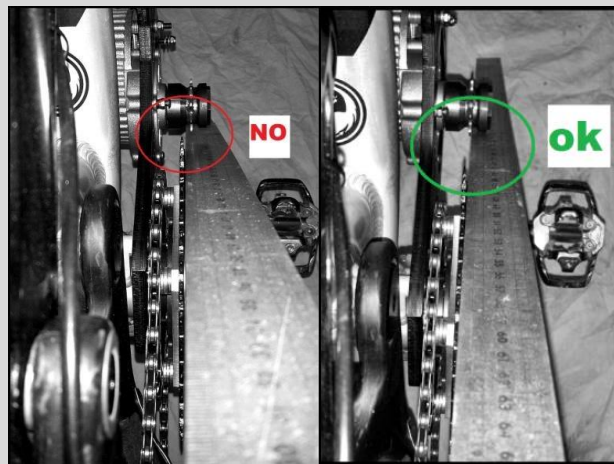
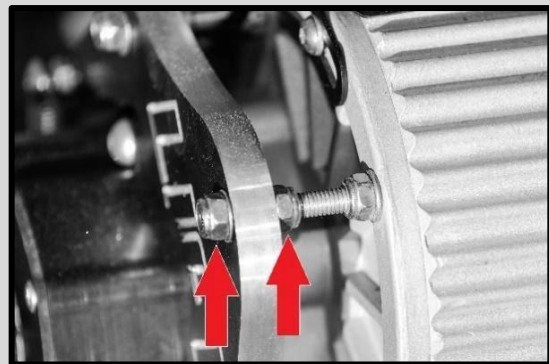
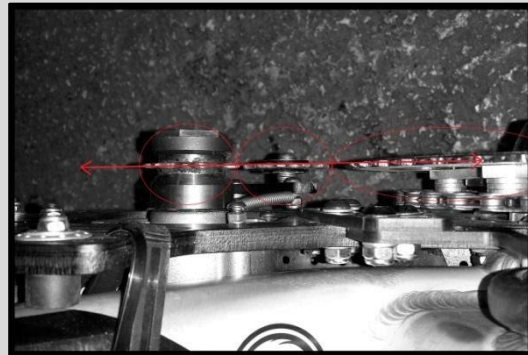

**-6- Set the number of pucks needed for the tendor.**  
**(Step only required on first edit)**

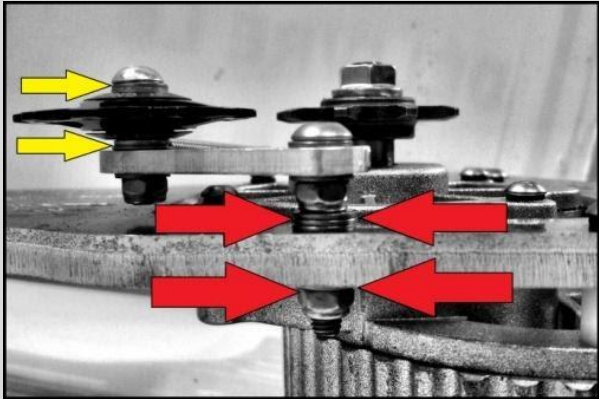
<b><u>Set the number of washers needed for the tendor.</u></b>	<b>Photos</b>
<p><i>-In the same way the chain tendor wheel mustl in front of the engine 8t cogs and and 38t Sprocket.</i></p> <p><i>-To get a good alignment, adjust the qty of washers provided on either side of the small roll on the chain tensioner (small yellow arrows) and tendor (big red arrows) in the photo attached.</i></p> <p><i>-Make sure that the chain tensioner has a minimum running game so that it can without excessive games rotate freely around the rotate axis.</i></p> <p><i>-In order to save time on your future mounts, be sure to note in the memo at the end of the document the number of calibration rings you use at the chain tendor and roll.</i></p>	



## **-7.1- Adjust the contact point on your frame**

**(Necessary step only on the first set-up)**

### **Adjust the contact point on your frame**

### **Photos**

#### **-A- Setting the engine casing support pad:**

*In most cases the engine comes to a stop on the down tube of the frame.*

*Before you tighten the system permanently you must (during the first assembly), place a sticky foam pellet provided in the kit on the down tube of your frame so as not to damage it.*

*To adjust the sticker pad, remove the right arm and spindle axle, then rotate the motor in a high position (as in the first photo attached)*

*This will determine the point of contact between the frame and the engine casing.*

*It is at this point of contact between the two red arrows in the photo opposite that you will stick the sticker foam.*

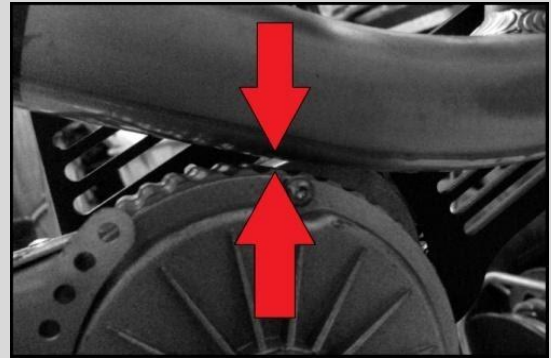
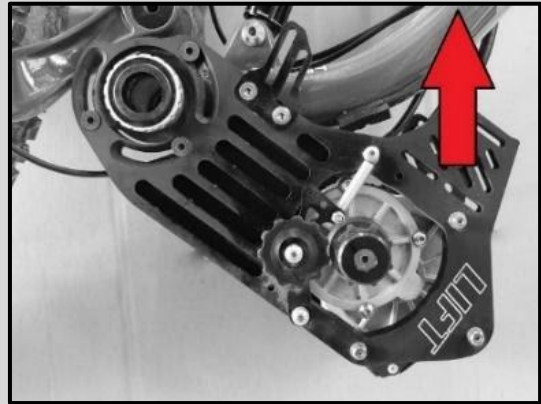

#### **-B- Setting of the silent block on main support :**

*-There are 2 silent for increase torsional stiffness.*

*These silent block press on the right and left side of the down tube of your frame.*

*-The rubber part of the pad is very long (see photo opposite) in order to adapt to all types of frame.*

*It is usually necessary to cut it to adjust it as best as possible.*



-To determine its ideal length, place the engine casing in contact with the downr tube, as in the previous step (7), then block the 3 screws.

-Determine the ideal location on the silent block, so it must be as much as possible on the flat section on the frame (you can position it in multiple ways)

-Finally, measure as in the photo opposite the gap between the frame and the aluminum motor plate (for exemple 10mm).

-Then, using a cutter, cut the pad to the same size by adding a margin of 3 millimeters, (cut to 13mm if you keep the same example) see photo opposite.

-Finally loosen the 3 ISCG screws, to have the necessary play to place the silent block at the chosen place, place the engine in a high position and then tighten the pads to the appropriate position.

-When tightening the system, the pads should touch the frame frankly and be very slightly compressed (as in the photo opposite red arrow).

**Then for the under frame version:**

-Squeeze the two BTR screws into the tube threaded to a maximum torque of 5Nm (**Be careful** if you tighten too hard you will twist the plate on the left side!) In order to come slightly pinch the tube below the frame, then lock with the counter nuts. (The tightening system can be moved to another hole depending on the frame versions)

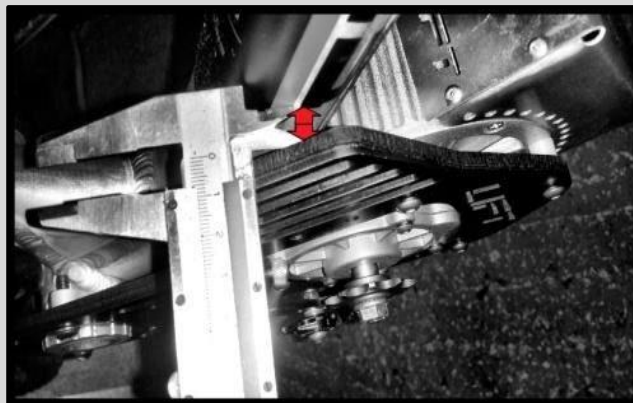

**Tightening of the upper engine / frame connection:**

On the upper part, the left and right plates must come to clamp the frame, so that the motor is correctly fixed.

**A / For the position under frame:**

-On the left side tighten the tension screw as far as possible then place the cable end in the tightening system (blue arrow).

- Pass the cable from the left side to the right side, adjust and position the protective rubber sheath on the cable so as to protect the frame.

- Place the cable around the right side BTR screw tightening (red arrow), then tension the cable as much as possible while tightening the BTR screw.

- Cut the excess cable with wire cutters, leaving about 4 cm, then squeeze the cable end supplied with the system, to avoid fraying the cable.

- Pass the remaining cable back through the rubber protection sheath (yellow arrow).

- Use an 8mm wrench to tighten the nut to tension the cable (green arrow), the goal is to compress the rubber pads against the frame.

-Finally, tighten the locknut with a 10mm wrench to lock the assembly.

**B / For the internal position:**

-The assembly steps are identical, it will suffice to pass the cable under the frame tube.

**WARNING :**

Check the platinum tightening regularly.

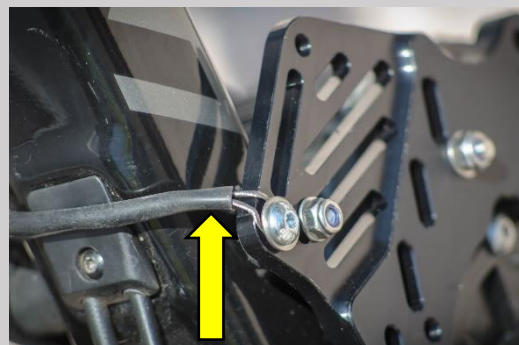
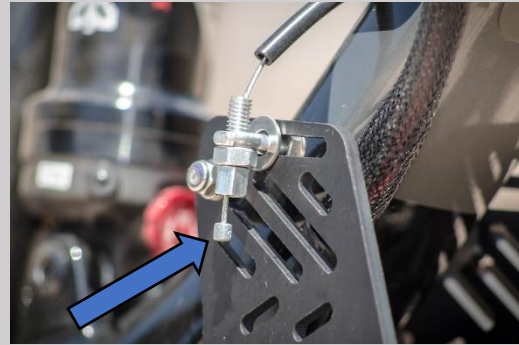

## **-7.2- Cover adjustment:**

**(Necessary step only on the first set-up)**

### **Adjust the engine hoof**

Adjust the engine cover, change its position so that it is placed against the frame and provides maximum clearance with the ground.

**Warning:** There are 3 screws for move that, 2 screws on the engine right side and x1 on the left side.

*For the internal mount version, it may be necessary to move the controller (the black box with wire connected to the engine) on a fixed part of the bike (as in the photo opposite) because it sometimes does not space because there is sometime rear arm , shock.*

*If the aluminum protective casing with the stickers touches, you can make a cut , or remove it.*

### **Photos**



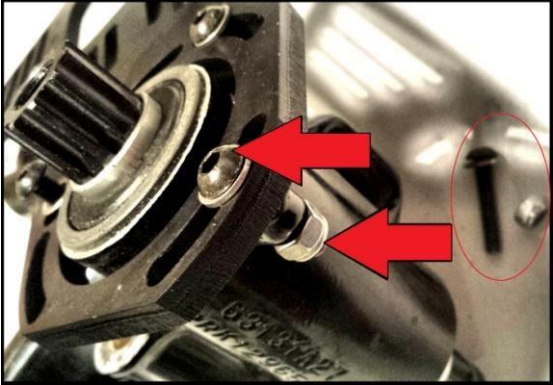
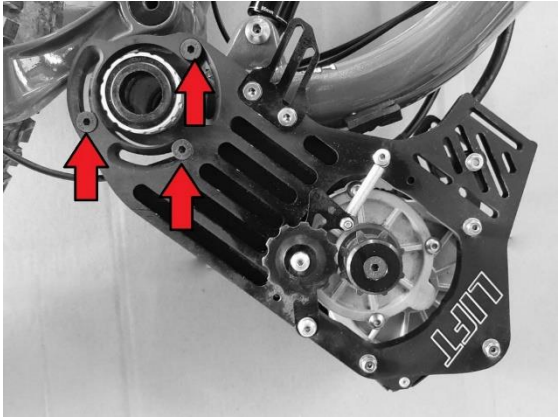

## **-8- Final system tightening:**

<b>Kit tightening</b>	<b>Photos</b>
<p>Once everything is perfectly aligned, you can tighten the system permanently.</p> <p>Different lengths of bolts support screws come with the kit: long and shortest.</p> <p>We recommend putting the longest ones if possible and adding counter-nuts as in the photo attached.</p> <p>If one or more screws are too long do not mount on one of the 3 studs (some threads may not be uncorking), use a shorter screw.</p> <p>In this case it is advisable to mount this screw with the "medium" loctite glue.</p> <p>Once the support is in place in the high position as seen above, tighten the 3 screws firmly, then place, if possible, the counter-nuts as pictured opposite, or add the net brake.</p> <p><b>WARNING:</b> Make sure the screws are not too short, and that you use enough threading surface (mark: the screw should slightly protrude from the nut).</p> <p>Make sure the screws are not too long, nor do they hit other parts that may be moving later (shock absorber, brace or suspension arms, etc.).</p> <p>Make sure your suspensions work throughout their traveling without interaction with the engine system, deflate the suspensions if necessary to do this verification.</p>	 

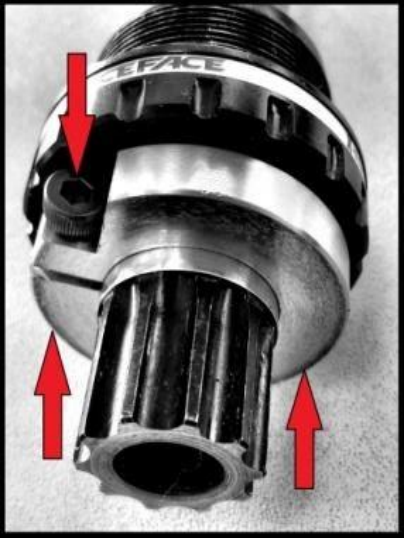

## -9- Final mounting of the crank:

Final mounting of the crank	Photos
<p><b><u>-9.1- If you have a classic threaded width frame type BSA 68/73 or BB92 / PF30/ BB30...</u></b></p> <p>-A- If you haven't already, tighten the screw of the right arm firmly on the crank spindle axle</p> <p>-B- Insert wedge washers between the crank and the bottom bracket (see stage 4)</p> <p>-C- Insert the crank axle into the bottom bracket bearings frame.</p> <p>-D- Place the clamp collar to the left. Push the collar against the bottom bracket bearing, tighten the collar with the BTR screw (<b>Warning:</b> maximum torque for the screw 2 Nm)</p> <p>-E- Place and then tighten the left arm (think about grease the grooves of the axle spindle)</p> <p><b><u>Your crank must run freely and without play !</u></b></p> <p>-If there is play, make sure the clamping collar is stun against the crank bearings.</p> <p>-If your crank doesn't turn freely, make sure the collar doesn't compress the pedal bearings too much.</p> <p><b><u>WARNING:</u></b> Check with each ride that your crank has no play, whether it's at the crank axle screws, and the tray screws that require special attention. If so, check the assembly's compliance.</p>	

## Final mounting of the crank

### -9.2- If you have a downhill frame with BB in 83mm or 107mm or HXR crank

- A-If you haven't already, tighten the right crank firmly on the right arm.
- B-Insert wedge washers between the crank and the bottom bracket (see stage 4).
- C-Insert the axle into the Bottom bracket.
- D-In most cases, it will not be possible to put the clamp on the left side (if possible follow the instructions of Step 1 above).

Otherwise you will need to add the wedge washers delivered with the kit and in some cases a "O" ring seal or elastic washer so as not to compress the bearings too much.

-Place the right arm and the axle on the bottom bracket, then put the soft rubber seal on the axis, then the necessary number of spacer to have about 16mm of grooves protruding on the axle.

-E- Place and then tighten the left arm firmly (tap slightly on the cranks to put the crank in place).

#### **Your crank must turn freely and without play !**

- If there is play, make sure there are enough spacer (add at least one spacer).

-If your crank doesn't turn freely, there are too many spacer (remove at least one stalling washer).

-On the HXR version make sure that the freewheel do not have a play left to right, pull the crank freewheel firmly from left to right,.

If you detect play left to right, add spacer on the axis. Otherwise you have derailment risk.

**WARNING:** Check with each riding session that your crank has no play and, if necessary, check the assembly's compliance.

## Photos



### **Very important Point:**

Check the crank bolt regularly.

It requires a very regular tightening over the first kilometers.

We recommend checking it every kilometers on the first 5 to 10 kilometers, while the crank this rode has the axle spindle.

Consider loosening the clamp collar with each tightening to allow the crank to move forward in the axis.

After a few tighten you can use the blue Loctite blue medium.

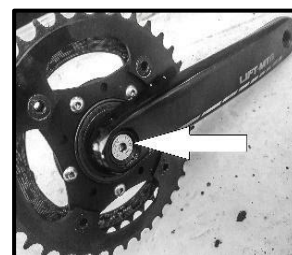
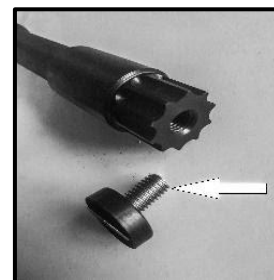

## **-10- Setting up the primary chain:**

We strongly advise you before anything else to check one last time the correct alignment of the 8t motor cogs / tendon / 38t sprocket (see step 5) to avoid any incident that could damage the system.

Now place the primary transmission chain on the sprocket, on the pull on the tendon. And 8t cogs

So the chain must be rotate freely with pulley , sprocket and 8t cogs.

**WARNING:** Do not manipulate the bike's chain or transmission when the motor is plugged with battery.



## -11- Mounting the chain cover:

Mounting the chain cover	Photos
<p>During the first tests you do not have to mount the chain cover. This will allow you to check the correct alignment and quickly and easily disassemble the chain if necessary.</p> <p>Once you are sure that everything is perfectly aligned, and if you have already try the system one or two time you can mount the chain cover with the two BTR screws (red arrow), as in the photo attached and then place the locking plate with the two screws (green arrow).</p> <p><b>WARNING:</b> you need to remove the primary chain (step 10) to put the chain cover.</p>	

## -12- Connect On/OFF contactor and throttle

Connect on/OFF Throttle	Photos
<p>You'll notice that the control has soetime a multi-pin waterproof plug, which will allow you to leave the accelerator control in place and disassemble only the bike's engine, making handling easier and saves you time if you change configuration regularly.</p> <p>This pod is sometimes hard because of the seal.</p> <p>Make sure it is fully engaged or the system will not work.</p> <p><b>WARNING:</b> Always align the arrows of the two connection sheets at the risk of damaging the connection.</p>	

## **-13- Finalize editing**

### **Finish editing**

You must run the battery power cable along the down tube to the steering socket. All you have to do is finalize the assembly by putting on a few plastic collars if necessary to secure the cables.

An aluminum cable holder secures the Anderson connector: it can be put on the stem to prevent the wire from passing too far from right to left.

For some version fix the accelerator control cable with two plastic collars, either to the brake sheath or the derail sheath, as in the photo (green arrow), to prevent the cable from bending at the junction level when you turn the handlebars.

**WARNING:** It is imperative to check that your suspensions are working properly without interacting with the engine system and wires.

To do this, deflate your suspensions and make them work to see if they work all the way without the wheels or another part colliding or obstructing the classic operation of your bike.

If you have any doubts, don't use your bike, and ask a competent person for advice.

### **Note on the connection**

We use Anderson connections.

If you notice a power outage, make sure the connection is clipped.

Sometimes the slat that locks the plug is not well clipped, causing bad contact.

This case remains extremely rare, and if this happens to you, you simply have to push the plug back for the slat to clip the plug correctly. You will find a set of connectors in advance in the parts kit of your kit, which will allow you to replace it if for some reason this is necessary.

### **Photos**





## **-14- Disassembly of your kit:**

### **Disassembly of the kit**

To disassemble your kit and find your classic bike, remove the plug from the manual control, remove the transmission chains, disassemble your crank with an ISIS-type crank snatch (see photo opposite). Note the dimensions and position of the axle spacer that you will remove from the memo at the end of the document (don't hesitate to make a simple diagram if necessary). Unlock the 3 ISCG screws from the engine support, dissociate the engine system, roll up your original pedal by handing over the necessary holds on each side, which you took care to note in the memo on the last page of this document...

### **Photos**



# Part 2: Precautions

## 1. The first test

-Here, the system is installed. To test it, leave the bike on the workshop foot, the wheel in the air away from any objects that can come into contact with the bike or wheel. Plug in the battery (*a small electrical arc can take place on the plug this is normal*), press the on/off button of the contactor: a light tells you that the system is on.

-Slowly turn on the accelerator to see if everything is working well.

**WARNING:** When plugging in or unplugging the battery cable, it is important not to pull the wire but rather the plug to preserve the connector setting.

## 2. Contact with water

-The **LIFT-MTB** system is waterproof to occasional projections, you can ride without fear on a slightly wet terrain or under a small downpour of a few minutes, but avoid as much as possible all water splashes on the system.

-If you're riding in the mud, preferably wash your bike with a moistened cloth rather than a water spray or high-pressure cleaner.

-If you need to clean the rest of the bike with a water jet or karcher, insulate the engine part, accelerator and connector with a plastic bag, for example, or disassemble the system.

-After washing dry as best as possible all parts that may have been in contact with the water.

-The battery and the control screen are absolutely not waterproof so do not expose them to water.

-If your system is inadvertently exposed to water, immediately unplug the battery and do not use it until it has dried as well as possible. It may be necessary to let it dry for a long time in a dry and warm place so that moisture that may be present escapes before it is re-energized. If you have any doubts, please contact us.

**Any return of a faulty system due to contact with water will not be taken under warranty.**

## 3. General Use Tips

-You will notice that once the engine is mounted, if you turn the wheel of the bike back, there is a very strong resistance, it is quite normal. **It is not advisable to operate the system in this direction..**

-Make sure you don't force the system by using it as a moped. In addition to increasing your consumption exponentially, this could decrease the lifespan of some parts.

**-For the engine to run in correct rev ranges and not overheat it is necessary:**

**Use the largest possible gables on the rear cassette**

Remember that unlike a car thermal engine, the more an electric motor takes turns the less it will consume, and the less it will heat up, so ideally you need to rotate your legs relatively fast to be in the right gears.

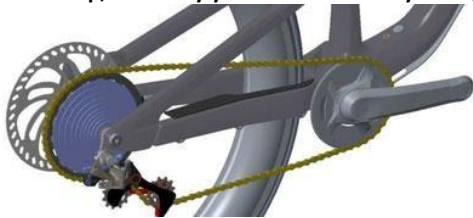

-For the longevity of your engine, it is therefore very important to respect this instructions. The control screen will allow you to use the kit to the best of its ability. Even if you haven't bought it yet, don't hesitate to read the instructions below to understand how KIT works.

-Regarding the battery, it is not protected by a shell. Be careful not to shock or crush it. Be sure to maintain a storage temperature: 10 to 42 degrees in a dry environment. In operation, the ideal discharge temperature ranges from -5 to 42 degrees. The battery is not waterproof especially do not expose it to water.

## **- BEWARE:**

Check **at each ride session** the tightening of the various elements that make up the system, including the all sprocket screws (x4), the ISCG screws (x3), the motor screws, the plastic collars, the axis/crank clamps / bolts.

Use the medium Loctite glue if necessary or if you note a recurrent loosening.

-Clean and grease the transmission chains regularly, check regularly the wear of your transmission parts (from the crank to the rear wheel) as a derail, chains, cassette, gables, trays. The use of the engine increases the stresses on these parts.

-To preserve the transmission of your bike, it is **IMPORTANT** to don't shift the gears with full power -you must absolutely let go of the power, pedal to shift the gear and then re-accelerate.

-Make sure the cables do not protrude, are not too exposed or are not pinched or frayed.

-Unplug the battery and store the cable in the bag during descents or tricky passages.

-Use only the kit on private land: use on public roads is strictly prohibited.

- Always wear appropriate protective equipment, helmet, gloves, knee pads, elbow pads and back protection.

## **4. We remind you that according to the law**

Bicycles for which the main energy source is not muscular (assist operated without pedaling and/or remaining in operation above 25km/h) are likened to either mopeds (if they are intended to travel on public roads, they must be subject to the same reception requirements as mopeds, either mini-motorbikes (machine directive requirements (2006/45/EC) and the 2008-491 act of 26 May 2008 (L321-1 and following)). As a result, bicycles equipped with motorization kits are considered to be motorized vehicles not received and reserved for exclusive use on approved circuit or "suitable terrain" within the meaning of Decree No.2009-719 of 17/06/2009. Restrictions on the use of these devices: - only for non-open lanes to public traffic - to minors under the age of 14 Decree No.2008-1455 of 30/12/2008 specifies that it is **mandatory** to declare the vehicle, to the Office of Safety and Road Regulation of the Ministry of the Interior, Overseas and Local Authorities. Users travelling on public roads would be subject to sanction (Articles L 321-1 and following of the Highway Code). These vehicles can be seized and confiscated by law enforcement.

## **5. Battery charge**

-Use only the original charger that comes with your battery, plug the charger's charging plug into the battery with color code, always charge the battery into its fireproof charging bag.

-A red light tells you that it is not full; A green light will tell you the end of the charge.

-The battery fits into your backpack, thanks to a cable with a fast connector of about 1.30 meters.

-It is connected to a connector usually placed near the steering socket.

-Take the battery out of the backpack for charging but keep the fireproof protective bag, never leave a battery charging unattended, **charge it in an airy area with no flammable thing nearby.**

-The charger can be equipped with a fan, it is possible that the noise is loud enough when charging, the fan shuts off at the end of the charge.

-The batteries are originally delivered with a charging and discharge control system (called BMS). If we go down too low in discharge or overload a battery, we will have irreparable damage. The BMS controls the overload and underload of the system.

Our system offers dual discharge protection (there are two BMS) and the charger will regulate the charge so that you don't have to worry more about charging and unloading your battery than your phone or laptop using the same technology.

-The storage mode of your battery: the ambient humidity, the storage temperature too low or too high are all elements that affect the life of the battery, for a long-term storage the ideal is: to store the battery from 30% to 60% of its maximum charge, in a dry place with temperatures between 5 and 25 degrees.

## **Periodic maintenance:**

-The LIFT-MTB system is designed to be maintained and repaired by the user himself autonomously, at a lower cost.

Preventively, we recommend that the gearbox system be greased, and above all to check the condition of the gearbox bearings every year or 2500 kilometres of use.

This represents one year of use for an average user who would do two 25-kilometre-week outings over a 50-week year of use.

The wear of the bearings varies depending on how you use the engine, if you don't force the engine excessively and you use a suitable jack, the replacement of these bearings will not necessarily be necessary for every check.



### **Verification procedure:**

- 1- put the system on OFF, remove the primary transmission chain
- 2- Undo the 8t cogs screw with a BTR key.
- 3- Simply remove the gable by pulling on it, gently clean and then grease the freewheel bearing inside the gable (this bearing does not require any particular change).
- 4- remove the 4 screws from the reducer, then remove the pan taking care not to damage the seal.
- 5- Note the direction of the big toothed wheel to put it back as originally.
- 6-check the condition of the two bearings that maintain the axle, change them if you have any doubt about their condition.



The bearing references are very common these are the references 6902-2rs and 608-2rs

-7- change the grease of the reducer if it is blackened, use a fat equivalent to the origin neither too thick nor too fluid.

-8- roll up the gearbox, keeping the following mount order:

bearing 608-2rs / large toothed wheel / motor axle / bearing 6902-2rs/ o ring/ gable / aluminum washer / screw m5 (tightening torque 7 Nm) /

LIFT-MTB trademark registered with INPI, national number 4204659 / SIREN number: 812 512 424

**If you have any questions, please contact us by** calling 337 68 91 49 91 or on [www.lift-mtb.com](http://www.lift-mtb.com) or [liftmtb@yahoo.com](mailto:liftmtb@yahoo.com)

# User control screen manual



The control screen is an option that is not included in the kit. However, this accessory is very useful for analyzing your consumption. If you don't have it you can buy it in our shop [www.lift-mtb.com](http://www.lift-mtb.com)

## 1/ Installation

The control screen has a support designed to be attached to your gallows. The support is fixed between the hood of the steering game and the gallows.

It may in some cases require the use of one or more steering holds and a longer hood tightening screw.

Note that you can also deport the screen in a backpack or any other place on the bike.

**WARNING:** Only handling the steering parts of your bike if you are sure of yourself a bad winding could cause a fall or loss of control of your bike.

## 2/ Branch

You have to connect the screen in a specific direction: the wire (**source**) that is attached to the steering hood goes towards the battery, the other wire (**load**) connects to the engine output wire.

Make sure your handlebars are running freely without the wires being too tight or at risk of disconnecting.

**WARNING:** Scrupulously respect the meaning of the connection. Any reversal of polarity or non-compliance with the classic operating sense would irreversibly damage your control screen.



## 3/ How the different data works and interpretations

The main data is on the upper left and right, while on the lower part you will find other data that will tell you other additional information very useful also to optimize the management of your consumption.

**Top left:** Instant consumption, which is your instantaneous consumption. So you can see in real time what situations generate high consumption (example: too much jack, use of the engine in the start zone).



**The higher the number, the more you will consume.**

**the ideal is to try to have the lowest possible figure, for this always usesuitable jacks.**

Here is a table of the typical values of consumption.

Note that you need to separate peak consumption (maximum consumption peak of a few seconds) and continuous consumption (consumption over a longer period).

Consumption in AH	Comments
From 0 to 8Ah	Green Zone / Low Consumption
8 to 14 Ah	Blue Zone /Average Consumption
14 to 18Ah	Orange Zone / Heavy Consumption
18 to 23Ah	Red Zone / Extreme High Consumption



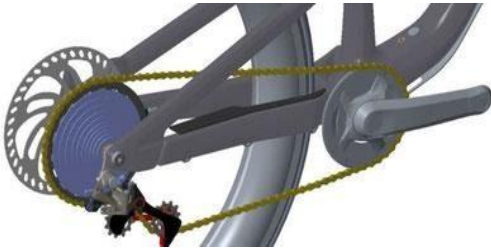

-For the engine to work properly, use biggest cogs on the rear cassette on the rear wheel as in the photo opposite.

Remember that unlike a car thermal engine, the more spin an electric motor takes, the less it will consume and the less it will heat up. For the longevity of your engine, it is therefore very important to respect this instruction.

-To properly assimilate this principle if we use the LIFT-MTB engine for too long on extreme consumption phases, this would mean, for example, using the engine of a car at a maximum speed in 1st<sup>on</sup> the highway...

-These high consumption phases can be used without problems for a few seconds but should not be too long to avoid excessive overheating, and premature wear of some parts.

**This red area of use is a bit like the red area of your car's turn account.**

**You can go without abusing it...**

### Estimated table LIFT-MTB consumption

Under: my level my usage	under : average consumption estimated in A/ h	Battery 8,7 A/H 313 wh		Battery 11,6 A/H 418 wh		Battery 14,5 A/H 522 wh		Battery 17,4 A/H 626 wh	
		(D+ l meter) Theorique difference in height of level in meter	Théorique mileage (km)	(D+ l meter) Theorique difference in height of level in meter	Théorique mileage (km)	(D+ l meter) Theorique difference in height of level in meter	Théorique mileage (km)	(D+ l meter) Theorique difference in height of level in meter	Théorique mileage (km)
i pedal lot	6	1218	49	1624	65	2030	81	2436	97
i pedal very well	8	1044	42	1392	56	1740	70	2088	84
i much pedal	10	957	35	1276	46	1595	58	1914	70
i'm in the middle	12	870	31	1160	42	1450	52	1740	63
i do not pedal hard	14	783	28	1044	37	1305	46	1566	56
i pedal vey little	16	609	34	812	46	1015	57	1218	69
i pedal really very little	18	435	21	580	28	725	35	870	42
i don't pedal	20	348	17	464	23	580	29	696	35

\* No contractual table, gived for average information.

**Top right:** Is the value of the Volt intensity remaining in the battery.

With this indication you will be able to have the battery value you have left more precisely than the display also present originally on the accelerator lever of the LIFT system. The display is fully charged and shows about 41 Volts.

From about 33V the system this puts it to safety and gives a lower assistance then cuts to the value of 31V..

(For a more accurate reading you have to wait a few seconds after using the engine in order for the data to stabilize.)

Below is a chart to help you read these directions, we find that:

Voltage display	% of battery remaining	Voltage display	% of battery remaining
41	100%	36	50%
40	90%	35	40%
39	80%	34	30%
38	70%	33	20%
37	60%	32	10%

**Every time you lose 1 Volt on the display at the top right, the battery loses 10% charge.**

## The lower part of the screen:

Other data scrolling through the display at the bottom left is:			
<b>00 :00 :00</b>	Useurea, Hr/ Min/ Sec (Salton versions, may notbe present)	<b>Ap</b>	Maximum consumption in peak in Ampere.
<b>Vm</b>	MinimalV oltage reached in Volt	<b>Wp</b>	Peak consumption in Watt
<b>Ah</b>	Total average consumption in Ampere hour	<b>Wh</b>	Total average consumption en Watt hour

The **Ah** data is very interesting. If, for example, your battery has a capacity of 10 A/h and your wattmeter screen indicates that you have consumed 1 A/h, you can deduce that you still have 9 A/h left, so you have 90% more energy left.

If you use 1 A/h on a 10 A/h battery during a climb, you will be able to do the same 10 times this climb.

It is generally considered that 1A/h can climb 100 meters of positive elevation D+

**WARNING:** To avoid an accident, don't be distracted by reading your screen. Focus on your driving.

**The control screen is non-waterproof:**

**Any contact with the water would damage it.**



**Operation:**

Our kit usually only works with the accelerator controller to handle the support, so the power regulator is for us, considered an option that can be added to your kit.

We recommend using the regulator on long climbs without obstacles or technical passage. For a technical pass the regulator will then be put in the OFF position, you will then only use the throttle to manage the assistance. (Just as your car's cruise control only serves you over long distances such as highways, and it will be disconnected to drive in the city).

We recommend the use of the pedal sensor below 25 km/h.

We remind you that both the regulator and the kit are not approved on public roads.

**ELECTRICAL ASSEMBLY:**

Attach the adjustment and stop button with the screw of the gallows hood.  
Handle the wires carefully, make sure the wire will not be bent, pulled or pinched when handling the handlebars.

-Connect the pedal sensor's connector to the primary beam connector (Red Arrows).

-Plug the connector of the knob (push button) on the trigger connector (Green Arrows).



**For models before August 2020** the operation remains the same, simply the wiring changes for this it will be necessary to connect the connector of the sensor in series to the trigger connector (yellow arrows in the photo).

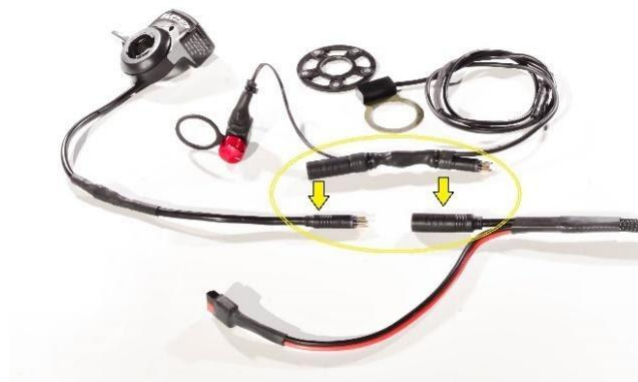

## MECHANICAL ASSEMBLY:

- Remove the bottom bracket (photo 1.1), fix the sensor between the bottom bracket and the frame (photo 1.2) on the left side only.

-Place if necessary the spacer between the bearing and the magnetized crown so that the gap between the sensor and the crown is about 2mm.

-Place the crown on the pedal axis, so that the part with the magnets is in front of the sensor at the "F" of the sensor's "SZFJ" handwriting.

-Depending on the place add spacer, or the clamp collar or photos 2.1 (Two possible mounts), then place the crank on the axle spindle in accordance with the adjustment instructions provided in the kit assembly manual.

-Be careful to handle queues and login cards carefully.



**Warning:** The area where the sensor detects movement is at the height of the "F" of the "SZFJ" script (photo 3.1) this letter must be placed as close as possible to the axis, any reversal of position of one of the elements will cause a malfunction.

## Photos with BSA-type bearings:

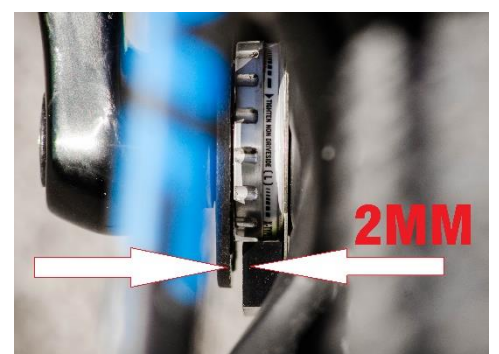



## Photos with pressed bottom bracket like to BB92/ BB30/ PF30:

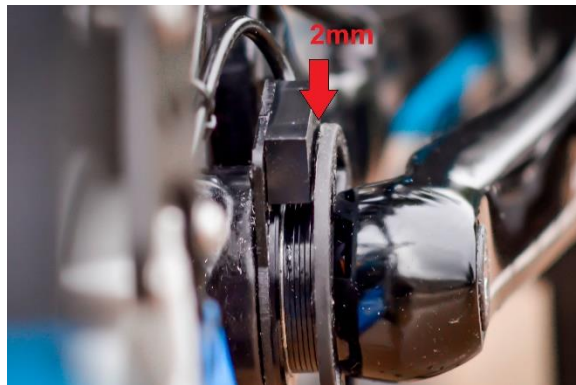
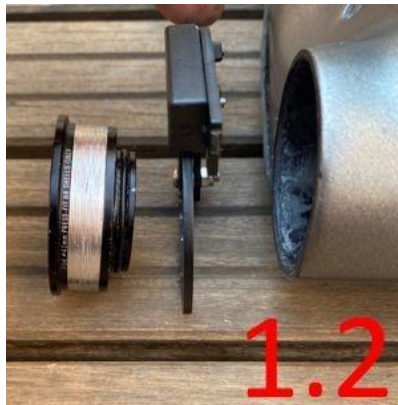

### How it works:

#### **Position 1 - ON:**

When the button is pulled upwards, the regulator is connected, the sensor detects the rotation of the crank, and give the power to the engine.

This power can be adjusted by rotating the button from 0% to 100%.

#### **Position 2 - OFF:**

When the button is pushed down, the regulator is disconnected, in which case only the throttle activates the engine as on the basic kit.

Note that the throttle is always a priority. if for example the regulator is on the ON position, with the knob set on 50% of the power, and you want to accelerate without pedaling or accelerating fully while pedaling it is possible thanks to the throttle.



**WARNING:** When installing, do not bend the wires , and do not twist them at the end of the knob, do not overexpose the knob to the water.